

# Off-Highway Systems

Drivetrain Products



## Achsen & Getriebe GmbH

Reparaturen / Störungsdienst

Giessenstrasse 14 A- 6522 Prutz Austria

Tel. +43/ (0)5472-21632 Fax +43/ (0)5472-21636

24h Notruf: +43/ (0)664-923 4586

Lastschaltgetriebe  
Drehmomentwandler  
Achsen und Antriebe  
OFF-Highway  
Kupplungen  
Kabelzüge  
Mining & Tunneling



**SPICER**



# Achsen & Getriebe GmbH

Reparaturen / Störungsdienst

Giessenstrasse 14 A- 6522 Prutz Austria

Tel. +43/ (0)5472-21632 Fax +43/ (0)5472-21636

**24h Notruf: +43/ (0)664-923 4586**

Lastschaltgetriebe  
Drehmomentwandler  
Achsen und Antriebe  
OFF-Highway  
Kupplungen  
Kabelzüge  
Mining & Tunneling

# Spicer® Off-Highway Systems

## Innovative People Who Give You the World

Dana Corporation is a global leader in the design, engineering, and manufacture of value-added products and systems for automotive, commercial, and off-highway vehicle manufacturers and their related aftermarkets. The company employs approximately 45,000 people worldwide. Founded in 1904 and based in Toledo, Ohio, Dana operates hundreds of technology, manufacturing, and customer service facilities in 30 countries.

Part of Dana Heavy Vehicle Technologies & Systems, Off-Highway Systems operates global facilities and several regional product technology centers, which serve more than 1,000 OEM customer facilities worldwide. We also manage 40 authorized independent service centers worldwide. All of our worldwide facilities are configured to offer our valued customers maximum connectivity.

How do these vast global resources benefit you? They enable us to develop and deliver innovative technology that yields the advantages your off-highway vehicles and customers demand, such as:

- Productivity
- Safety
- Comfort
- Efficiency
- Ease of operation
- Ease of maintenance
- Reduced NVH

Our products include a diverse mix of Spicer off-highway and on/off-highway axles and brakes, driveshafts and

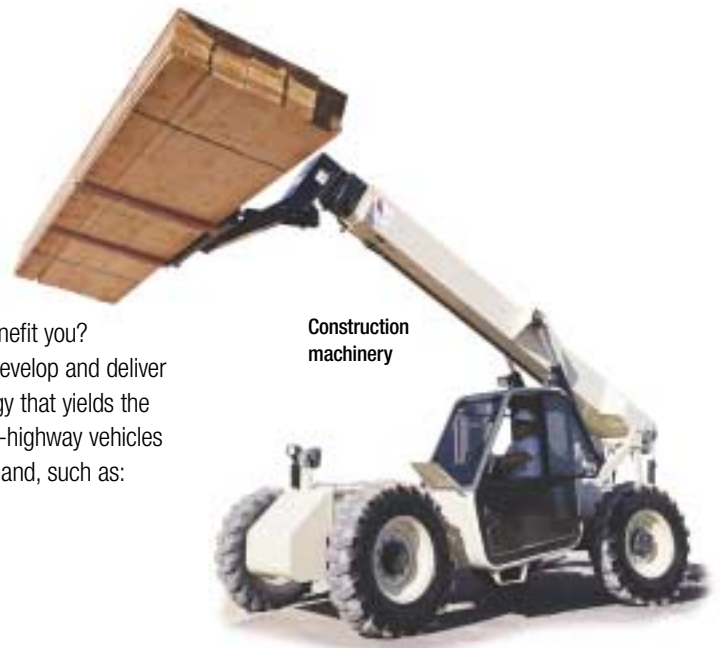

Construction machinery

end fittings, transmissions, transaxles, electronic controls, torque converters, and replacement parts and services. From variable-reach rough-terrain lift trucks and agricultural tractors to riding mowers and golf cars, Off-Highway Systems gives you a single, global source for reliable, advanced drivetrain technology.



Leisure/utility vehicles

But being a global off-highway leader is about much more than supplying quality products. It's our job to keep your off-highway vehicles up and running. The dedicated, responsive people of Off-Highway Systems work hard not only to meet your expectations – but also to exceed them. Achieving this goal requires comprehensive, cradle-to-grave service, as well as value-added support, fast emergency response, systems integration, supply chain management, and regional supply capabilities.

It also requires an ongoing commitment to strengthen our customer support structure. These transformation efforts include everything from enhanced electronic media and information processes, initial inquiry, new product development, and total systems solutions to improvements in quality, production, delivery, and cost. That's what it takes to be the partner you need – and that's our commitment to you.

Agricultural equipment



## Achsen & Getriebe GmbH

Reparaturen / Störungsdienst  
 Giessenstrasse 14 A- 6522 Prutz Austria  
 Tel. +43/ (0)5472-21632 Fax +43/ (0)5472-21636  
**24h Notruf: +43/ (0)664-923 4586**

Lastschaltgetriebe  
 Drehmomentwandler  
 Achsen und Antriebe  
 OFF-Highway  
 Kupplungen  
 Kabelzüge  
 Mining & Tunneling

*People Finding A Better Way®*

# Spicer® Research and Development Capability

## We Know the Global Terrain

You need partners who know the off-highway industry and who understand the importance of consistent performance and support. That's why Off-Highway Systems engineers are committed to finding better ways to meet the needs of customers like you. Backed by global research and development centers, we are able to deliver the ideas, resources, and information-sharing you depend on – no matter what time zone you're in.



Spicer Transmission R&D Center – Brugge, Belgium

real-world conditions on our components and systems. From increasing the life of bearings, sealing products, gears, and shafts to designing and delivering a completely balanced drivetrain system, we are committed to improving our processes, products, and systems to meet all your off-highway drivetrain needs – now and in



Spicer Axle R&D Center – Arco, Italy

Solving your challenges requires advanced capabilities beyond traditional product design, testing, and prototyping. That's why we provide state-of-the-art design techniques such as computer-aided design (CAD), finite element analysis (FEA), failure modes and effects analysis (FMEA), and rapid prototyping. These capabilities allow us to quickly design and model complex structures and systems, identify any potential issues, and ensure robust designs for final products relative to their applications.

In conjunction with computer-based testing, we offer a complete line of laboratory

testing, including fatigue, environmental, simulation, and metallurgical testing. Complex mathematical models and arithmetic analysis provide for advanced development. Beyond the lab, we provide on- and off-road test tracks that inflict

the future. Advanced electronic design and application to our systems and components ensure improvements in safety, productivity, comfort, efficiency, ease of operation, maintenance, and reduced NVH.



Advanced design, testing, and prototype facilities



Spicer Axle Engineering Center Test Track



**Achsen & Getriebe GmbH**  
 Reparaturen / Störungsdienst  
 Giessenstrasse 14 A- 6522 Prutz Austria  
 Tel. +43/ (0)5472-21632 Fax +43/ (0)5472-21636  
 24h Notruf: +43/ (0)664-923 4586

Lastschalgetriebe  
 Drehmomentwandler  
 Achsen und Antriebe  
 Off-Highway  
 Kupplungen  
 Kabelfzüge  
 Mining & Tunneling

## Systems Integration

You depend on your partners to bring more and more to the table. To that end, we're committed to continually enhancing our product and systems integration capabilities – everything from innovative systems design and multiple-component modular assembly to total systems solutions for the entire drivetrain.

Off-Highway Systems offers many value-added services and benefits to complement our complete line of products, advanced processes, systems capabilities, and specific product design and engineering centers.

Complete Spicer® drivetrain systems capability



These advanced capabilities include:

- A technologically comprehensive test facility within **Dana Technical Resource Park** that includes test-track proving grounds, computer-integrated manufacturing, rapid prototyping, metallurgical service, advanced technical training, and virtual engineering.

- The ability to leverage our **Global Asset Base** to provide you with high-quality, cost-effective products, delivered where you need them – when you need them.



Dana Technical Resource Park – Ottawa Lake, MI

- A commitment to **Quality Standards** and continuous improvement through programs such as QS 9000, ISO 14000, Six Sigma, Kaizen Blitzes, and **Value Analysis/Value Engineering**.
- Round-the-clock global engineering centers with satellite regional capabilities offering **Virtual Time™ Engineering**.



## Achsen & Getriebe GmbH

Reparaturen / Störungsdienst  
Giessenstrasse 14 A- 6522 Prutz Austria  
Tel. +43/ (0)5472-21632 Fax +43/ (0)5472-21636  
24h Notruf: +43/ (0)664-923 4586

Lastschaltgetriebe  
Drehmomentwandler  
Achsen und Antriebe  
OFF-Highway  
Kupplungen  
Kabelzüge  
Mining & Tunneling

*People Finding A Better Way®*

# Spicer® Products, Modules, and Systems

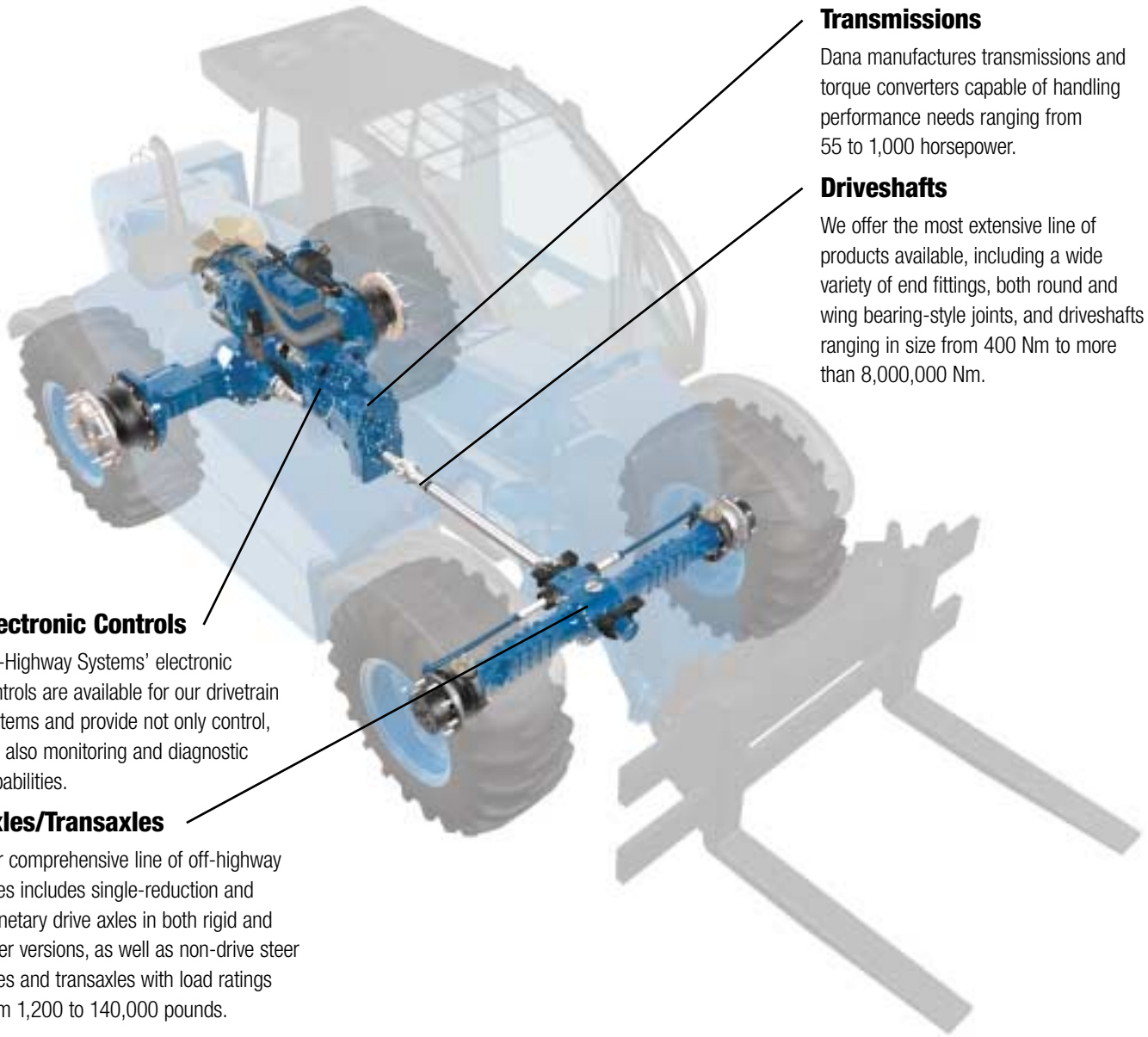

## Transmissions

Dana manufactures transmissions and torque converters capable of handling performance needs ranging from 55 to 1,000 horsepower.

## Driveshafts

We offer the most extensive line of products available, including a wide variety of end fittings, both round and wing bearing-style joints, and driveshafts ranging in size from 400 Nm to more than 8,000,000 Nm.

## Electronic Controls

Off-Highway Systems' electronic controls are available for our drivetrain systems and provide not only control, but also monitoring and diagnostic capabilities.

## Axes/Transaxles

Our comprehensive line of off-highway axes includes single-reduction and planetary drive axes in both rigid and steer versions, as well as non-drive steer axes and transaxles with load ratings from 1,200 to 140,000 pounds.

## Complete Systems Solutions





Whether it's for withstanding the harsh environment of the construction or mining industry, or for customizing a niche vocational vehicle, Off-Highway Systems is capable of providing more than just components. Our complete product line provides integrated systems

solutions and offers technically advanced drivetrain systems engineered for superior performance. See our Web site at [www.dana.com/offhighway](http://www.dana.com/offhighway) to download current condensed and in-depth specifications.

**Achsen & Getriebe GmbH**  
Reparaturen / Störungsdienst  
Giessenstrasse 14 A- 6522 Prutz Austria  
Tel. +43/ (0)5472-21632 Fax +43/ (0)5472-21636  
24h Notruf: +43/ (0)664-923 4586

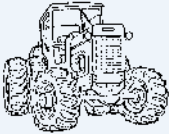
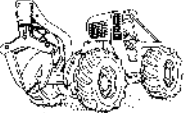
Lastschaltgetriebe  
Drehmomentwandler  
Achsen und Antriebe  
OFF-Highway  
Kupplungen  
Kabelzüge  
Mining & Tunneling

# Complete Market Coverage

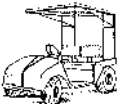
Markets	Market Conditions	Products	Applications
<b>Construction</b> 	Construction equipment is subject to some of the harshest environmental factors. That's why Spicer® products are engineered for versatility, reliability, and ease of service.	Single-reduction and planetary axles; transmissions; transfer cases; multiple brake options; torque converters; driveshafts and end fittings.	Pavers; haulers; cranes; wheeled and backhoe loaders; ditchers and trenchers; site dumpers; compactors and rollers; wheeled excavators; variable-reach and vertical-mast lift trucks.
<b>Agriculture</b> 	To meet the world's growing demand for affordable, reliable, state-of-the-art agricultural equipment, Off-Highway Systems provides the expertise, design assistance, and systems solutions to handle whatever crops up.	Single-reduction, planetary, and non-drive axles; multiple brake options; transaxles; driveshafts and end fittings.	Two- and four-wheel drive agricultural tractors; articulated and non-articulated tractors; vineyard tractors; compact tractors; combines; crop handlers; and specialty harvesting equipment.
<b>Forestry Equipment</b> 	From steamy rainforests to frigid timber tracts, loggers require dependability and service in any climate and terrain. We cultivate new technology and superior solutions.	Planetary axles; multiple brake options; transmissions; electronic controls; torque converters; driveshafts and end fittings.	Log skidders; feller bunchers; tree harvesters; and forwarders.
<b>Underground Mining</b> 	OEMs worldwide depend on Spicer products to keep mining equipment operating with minimal maintenance and downtime.	Planetary axles; multiple brake options; powershift transmissions; electronic controls; driveshafts and end fittings.	Scoops; shuttles; load-haul dumps; personnel carriers; self-propelled blast hole drills; and site utility vehicles.
<b>Material Handling</b> 	From lightweight lift trucks to specialized material movers, Spicer works with you to find solutions that are affordable, reliable, perfectly suited to your end-users' needs.	Electronic controls; planetary and single-reduction axles; transaxles; powershift transmissions; driveshafts and end fittings.	Vertical-mast lift trucks; in-plant lift trucks, aerial lift platforms, airport support vehicles; tugs; and baggage tows.
<b>Outdoor Power Equipment</b> 	The transmissions and transaxles in the Spicer outdoor power equipment product line may be some of our smallest, but they're designed for reliability, efficiency, and big performance.	Single-reduction axles; mechanical and hydrostatic transaxles; brakes; driveshafts and end fittings.	Front and rear engine mowers; walk-behind mowers; garden tractors; and commercial mowers.
<b>Leisure/Utility Vehicles</b> 	Spicer products are available customized for your gas or electric application.	Transaxles; single-reduction and non-drive axles; brakes; driveshafts and end fittings.	Golf cars; utility vehicles; ATVs; other small engine and electric motor-driven vehicles.



**Achsen & Getriebe GmbH**  
 Reparaturen / Störungsdienst  
 Giessenstrasse 14 A- 6522 Prutz Austria  
 Tel. +43/ (0)5472-21632 Fax +43/ (0)5472-21636  
 24h Notruf: +43/ (0)664-923 4586

Lastschaltgetriebe  
 Drehmomentswandler  
 Achsen und Antriebe  
 OFF-Highway  
 Kupplungen  
 Kabelzüge  
 Mining & Tunneling

*People Finding A Better Way®*

# Spicer® Products – Leading the Pack in Off-Highway Performance

## Spicer Axles

Spicer axles are designed to deliver maximum performance levels. Our innovative axles all offer features and specifications to accommodate your particular application needs. The designs we offer within our single-reduction, planetary, specialty, and transaxle lines have been meticulously engineered to provide easy, low-cost service and maintenance, along with rugged, reliable performance for most off-highway applications. In addition, many options are available on most series, so you can customize a product to meet your specific needs.

## Planetary and Single-Reduction Axles

Spicer planetary steer axles are available in various track widths, ratios, and capacities, enabling them to accommodate a multitude of applications, including cranes, rough-terrain lift trucks, backhoes, agricultural tractors, and wheeled excavators.

Our planetary rigid axles are available in many different ratio and size ranges that can accommodate many vehicle requirements. Potential applications include front-end loaders, scrapers, compactors, large industrial lift trucks, agricultural vehicles, and forestry equipment. Spicer single-reduction axles are available in load-carrying capacities from 3,300 to 18,000 pounds, with multiple brake options. They are available in drive-steer, rigid, and non-drive for ditchers, small bucket loaders, trenchers, and utility vehicles.

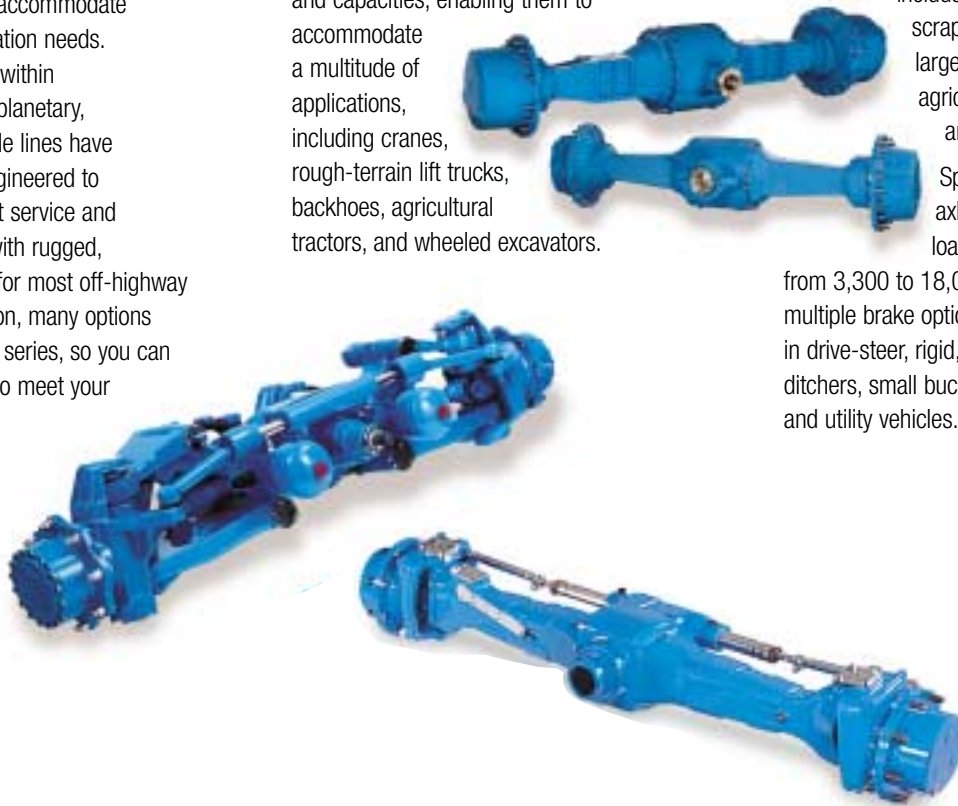

 **Achsen & Getriebe GmbH**  
Reparaturen / Störungsdienst  
Giessenstrasse 14 A- 6522 Prutz Austria  
Tel. +43/ (0)5472-21632 Fax +43/ (0)5472-21636  
24h Notruf: +43/ (0)664-923 4586

Lastschaltgetriebe  
Drehmomentwandler  
Achsen und Antriebe  
OFF-Highway  
Kippklangen  
Kabelzüge  
Mining & Tunneling



## Spicer® Outdoor Power Equipment and Leisure/Utility Vehicle Products

As the world's largest producer of electric drive axles for the leisure/utility vehicle market, Spicer designs, manufactures, and assembles axles, transaxles, transmissions, driveshafts, and brakes for the specialized off-highway market segment dedicated to outdoor power equipment and leisure/utility vehicles. Whether your application is hydrostatic, mechanical, or electric drive, we offer a complete line of products for your small vehicle power transmission needs.

### Outdoor Power Equipment Products

- Single-Speed Transmissions
- Multi-Speed Transmissions
- Axles
- Transaxles
- Brakes and Components



## Spicer Transmissions

A leading supplier of off-highway transmissions, we offer transmissions that are manufactured in both Europe and North America. Assembled and sourced globally, Spicer off-highway transmissions provide the latest technology for the diverse needs of off-highway vehicle end-users.

Focusing on productivity, ease of use, safety, comfort, and efficiency, we also address the very specific needs of each application's duty cycle.

### Transmission Products

- Powershift Transmissions
- Hydrostatic Transmissions
- Mechanical Transmissions
- Transfer Cases
- Torque Converters
- Hydrostatic Gear Boxes



## Spicer Electronic Controls

For the off-highway market, we manufacture electronic controls that are designed and engineered to provide smooth, efficient shifting operation. State-of-the-art features include electronic modulation, electronic throttle and brake-by-wire capability, electronic single-pedal drive capability, and differentiation between vehicle speed and engine RPM for auxiliary use.

Spicer electronic controls are capable of improving vehicle and operator performance by shifting automatically at predetermined speed and load points. Not only do they offer an advanced level of drivetrain control and ease of use, they also provide for monitoring and diagnostic capabilities. These capabilities in turn enhance productivity, safety, and efficiency.



## Spicer® Driveshafts

Spicer Off-Highway brings together the world's most powerful driveshaft-related innovations and the most extensive product offering, for everything from the smallest machines to the largest wheel loaders and mine haulers.



Our driveshafts are ideal for the rigorous demands of most mobile off-highway and industrial applications.

With standard torque capacities ranging from 400 Nm to 1,750,000 Nm\*, and lubrication packages ranging from extended to permanently lubricated – Spicer has the driveshaft to fit your needs.



\*Joint-venture partnerships have allowed the development of torque capacities in excess of 8,000,000 Nm. Contact a Spicer engineer for more information.

To supplement our comprehensive driveshaft line, Spicer offers multiple end fittings, including wing-style end yokes, as well as full round or Quick Disconnect™ options for round-style bearings. We also offer flanges in SAE and DIN, or cross-serrated.



### Driveshaft Product Lines

- Spicer® 10 Series™
- Spicer® Life Series®
- Spicer® Italcardano™
- Spicer® Compact 2000™
- Spicer® Ayra-Cardan™
- Spicer® GWB™

### A Complete Product Line to Satisfy Every Application

Look to us for a full line of products – allowing for everything from multiple innovative system designs to single-source product capabilities.

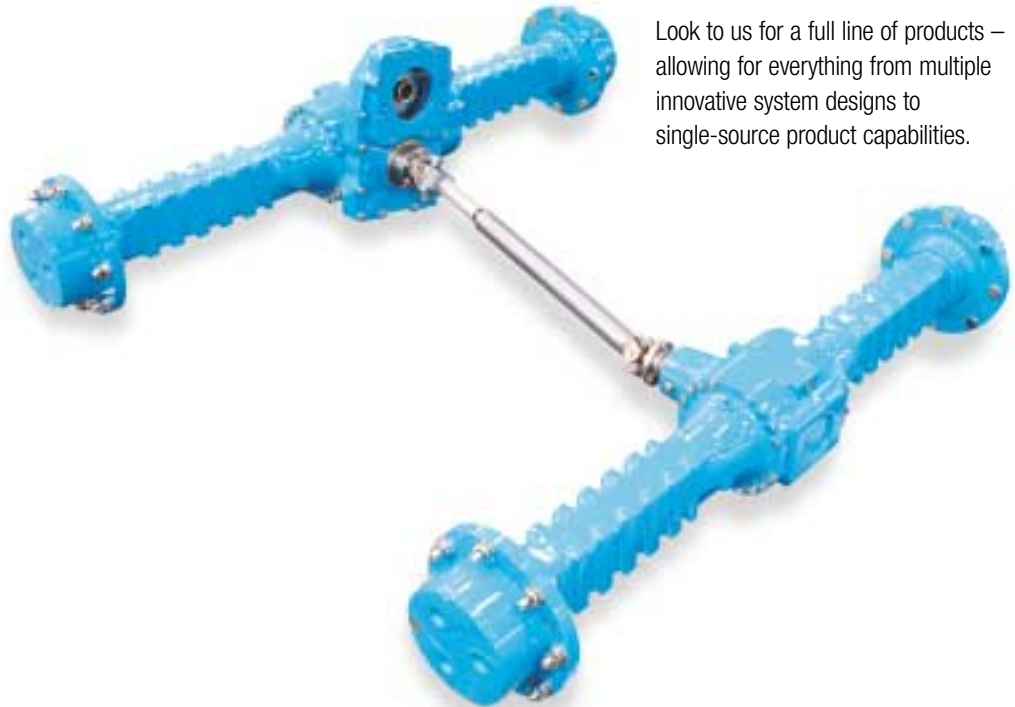

## Achsen & Getriebe GmbH

Reparaturen / Störungsdienst  
Giessenstrasse 14 A- 6522 Prutz Austria  
Tel. +43/ (0)5472-21632 Fax +43/ (0)5472-21636  
24h Notruf: +43/ (0)664-923 4586

Lastschalgetriebe  
Drehmomentwandler  
Achsen und Antriebe  
OFF-Highway  
Kupplungen  
Kabelzüge  
Mining & Tunneling

# Spicer® Service Parts

## Moving Heaven and Earth to Keep You Up and Running

Because product support strongly influences your off-highway component purchase, we back each sale with value-added service, maximizing your return on investment. Dana's Off-Highway Systems Service Parts is a worldwide, single-source supplier committed to supporting you with the very best original equipment parts and service. We offer a complete package of replacement parts and service for Dana's traditional Spicer branded components, as well as the components and brands that Dana has acquired. Spicer now includes Clark,<sup>™</sup> Clark-Hurth,<sup>™</sup> Sige,<sup>™</sup> Comaxle,<sup>™</sup> Kirkstall,<sup>™</sup> Spicer® GWB,<sup>™</sup> Spicer® Italcardano,<sup>™</sup> and Spicer® Ayra-Cardan.<sup>™</sup> These acquired brands of off-highway axles, driveshafts, and transmissions fall under the Spicer brand name. To make sure you're getting genuine original equipment components for these brands, demand Spicer.

We maintain an extensive parts inventory to assist in emergency situations or day-to-day business. Parts are available to you via two global distribution centers: one in Crossville, Tennessee, and the other in Mulheim, Germany. To further our commitment, we have partnered with authorized service centers located in dozens of countries on six continents, allowing us to span the globe in minutes to respond to your requests. We are there to support our original equipment customers and their authorized distribution channel.



## Spicer services include:

- Focused OEM Parts Distribution
- Fast, Reliable Parts Distribution
- Parts and Marketing Support
- Product Training
- Support Publications
- Rebuilding and Remanufacturing Services
- New Product Launch Support
- Technical Support and Troubleshooting
- Direct Sales Support
- Customer Internet Ordering System at [www.DanaMATE.com](http://www.DanaMATE.com)

For all your off-highway vehicle requirements, from concept to service parts support, count on genuine Spicer axles, transmissions, and driveshafts.

Two comprehensive global distribution centers: Crossville, Tennessee, USA (left) and Mulheim, Germany (below)

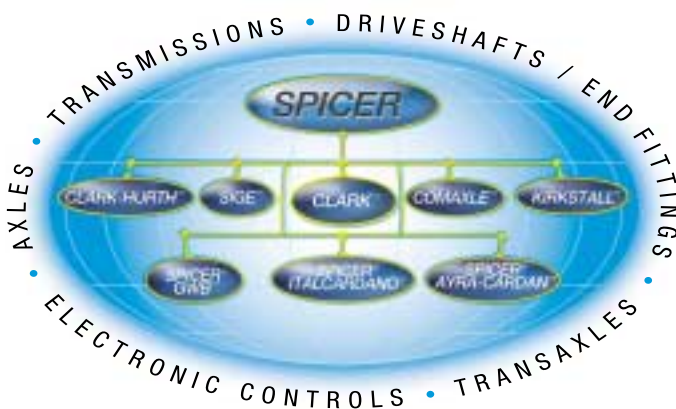

For genuine, original equipment parts and service for all these brands, the only name you need to know is Spicer.



## Achsen & Getriebe GmbH

Reparaturen / Störungsdienst  
Giessenstrasse 14 A- 6522 Prutz Austria  
Tel. +43/ (0)5472-21632 Fax +43/ (0)5472-21636  
**24h Notruf: +43/ (0)664-923 4586**

Lastschaltgetriebe  
Drehmomentwandler  
Achsen und Antriebe  
OFF-Highway  
Kupplungen  
Kabelzüge  
Mining & Tunneling

*People Finding A Better Way®*



# Achsen & Getriebe GmbH

Reparaturen / Störungsdienst

Giessenstrasse 14 A- 6522 Prutz Austria

Tel. +43/ (0)5472-21632 Fax +43/ (0)5472-21636

**24h Notruf: +43/ (0)664-923 4586**

Lastschaltgetriebe  
Drehmomentwandler  
Achsen und Antriebe  
OFF-Highway  
Kupplungen  
Kabelzüge  
Mining & Tunneling

## Off-Highway Systems

Asia Pacific (China): 86 2 153 831100

Asia Pacific (Korea): 82 2 563 9451

Europe (Italy): 39 0464 580227

North America (USA): 704 878 5886

South America (Brazil): 55 15 3238 6092

## Application Policy

Capability ratings, features, and specifications vary depending upon the model, type of application, and type of service. Application approvals must be obtained from Spicer. We reserve the right to change or modify our products or our product specifications, configurations, or dimensions at any time without notice.

